

Kit 1475

HYUNDAI H-1, 5-dr Van, 08-*

HYUNDAI iLoad, 5-dr Van, 08-**

HYUNDAI iMax, 5-dr Bus, 08-**

HYUNDAI Starex, 5-dr Van, 08-*

* with dual sliding doors

** with dual sliding doors (Asia)

480R
754

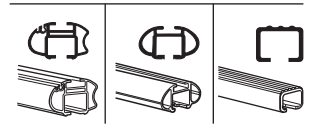
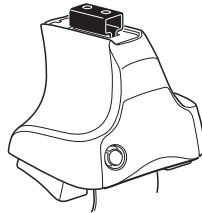

480

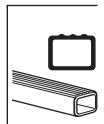
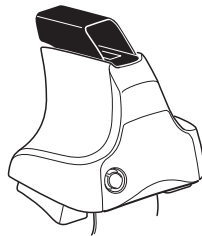

750

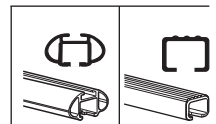
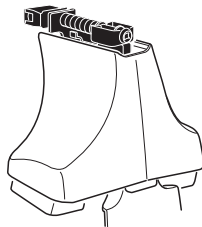

THULE[®]
SWEDEN

x1

x4

x4

x4

480R/754

x1

x4

x4

x4

480

x1

x4

x4

x4

750

| | | | | |
|----------------------|----|----------------------|----------|----|
| | | | | |
| x2 x2 x2 x4 | x2 | x2 x2 x4 x4 | x2 x2 | x2 |

1342 x 4

289 x 4

x 1

Kit

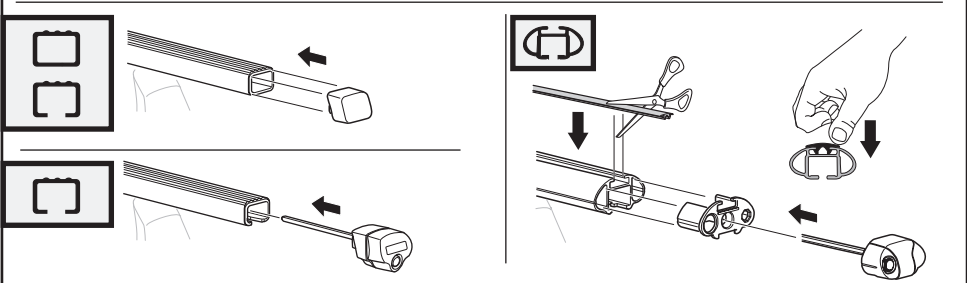
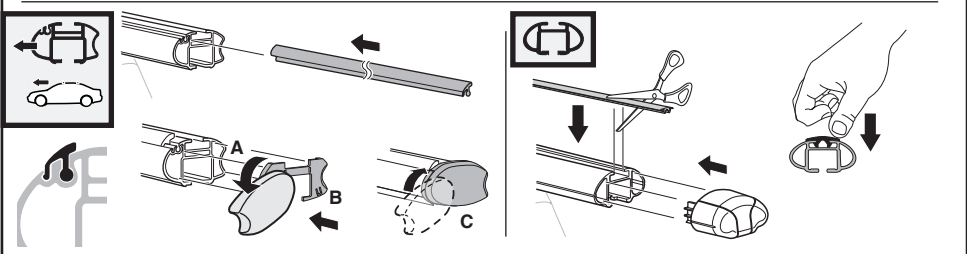
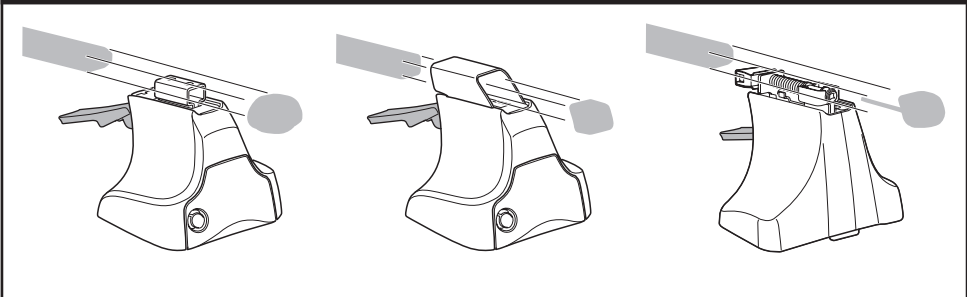
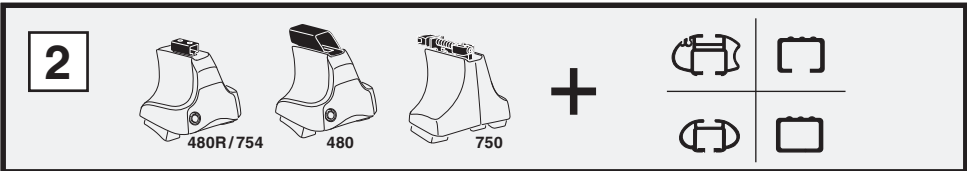
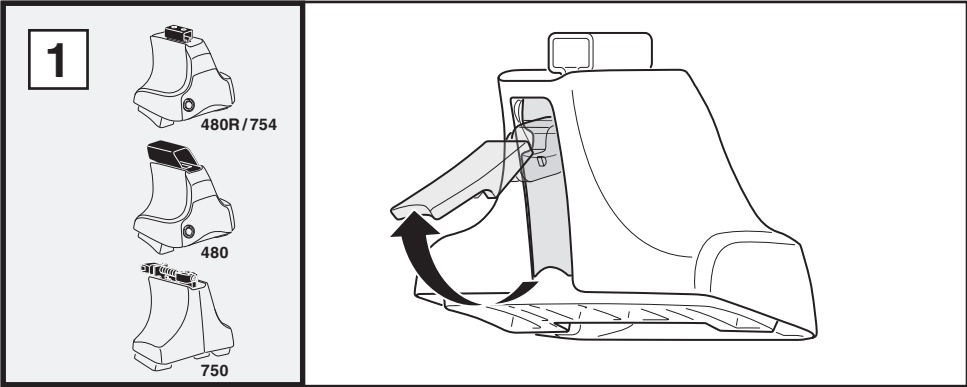

3

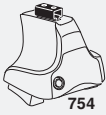

754

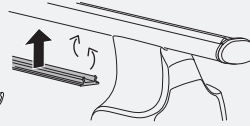
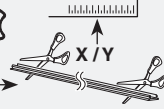

750

1

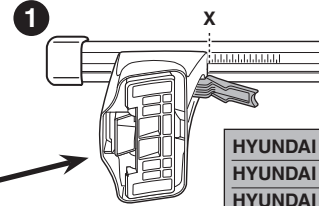
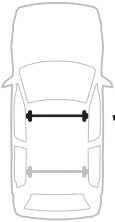

2

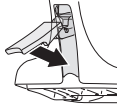

| | X |
|-------------------------------|------|
| HYUNDAI H-1, 5-dr Van, 08- | 54,5 |
| HYUNDAI iLoad, 5-dr Van, 08- | 54,5 |
| HYUNDAI iMax, 5-dr Bus, 08- | 54,5 |
| HYUNDAI Starex, 5-dr Van, 08- | 54,5 |

1

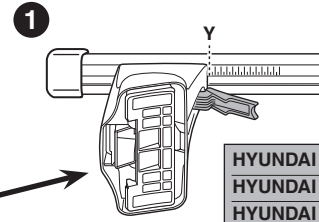

2



| | Y |
|-------------------------------|------|
| HYUNDAI H-1, 5-dr Van, 08- | 53,5 |
| HYUNDAI iLoad, 5-dr Van, 08- | 53,5 |
| HYUNDAI iMax, 5-dr Bus, 08- | 53,5 |
| HYUNDAI Starex, 5-dr Van, 08- | 53,5 |



480R



480

1

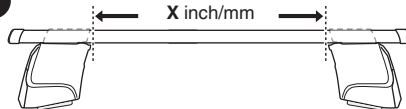

2



| | X inch | X mm |
|-------------------------------|---------|---------|
| HYUNDAI H-1, 5-dr Van, 08- | 47 1/8" | 1196 mm |
| HYUNDAI iLoad, 5-dr Van, 08- | 47 1/8" | 1196 mm |
| HYUNDAI iMax, 5-dr Bus, 08- | 47 1/8" | 1196 mm |
| HYUNDAI Starex, 5-dr Van, 08- | 47 1/8" | 1196 mm |

1

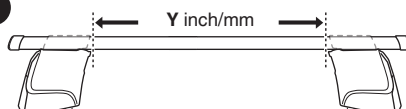

2



| | Y inch | Y mm |
|-------------------------------|---------|---------|
| HYUNDAI H-1, 5-dr Van, 08- | 46 3/4" | 1186 mm |
| HYUNDAI iLoad, 5-dr Van, 08- | 46 3/4" | 1186 mm |
| HYUNDAI iMax, 5-dr Bus, 08- | 46 3/4" | 1186 mm |
| HYUNDAI Starex, 5-dr Van, 08- | 46 3/4" | 1186 mm |

4

HYUNDAI H-1, 5-dr Van, 08-
HYUNDAI iLoad, 5-dr Van, 08-
HYUNDAI iMax, 5-dr Bus, 08-
HYUNDAI Starex, 5-dr Van, 08-

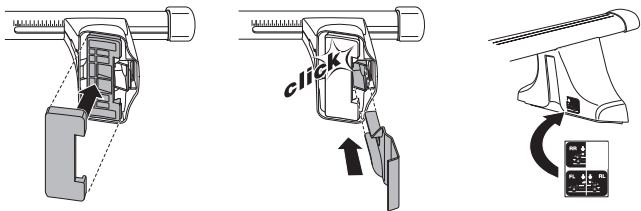
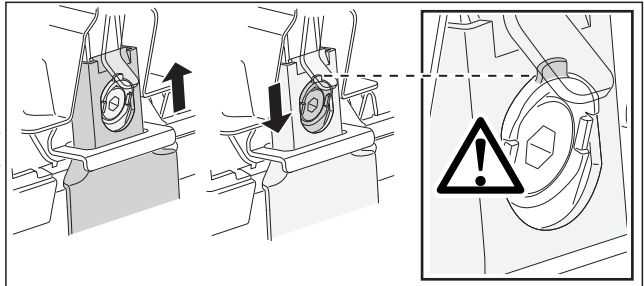
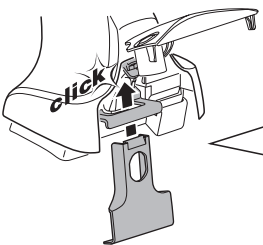
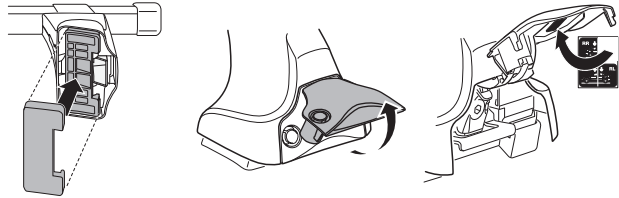
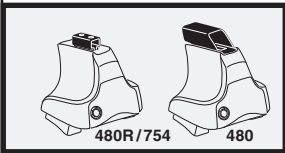
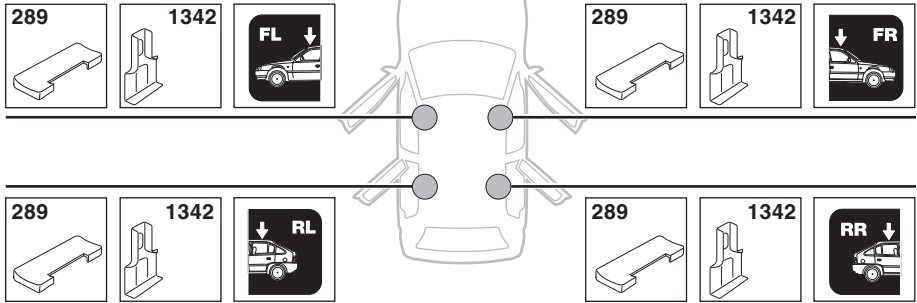

5

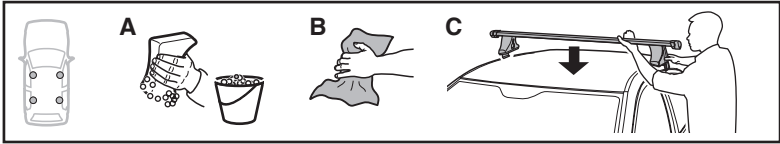

| | X mm | Y mm | X inch | Y inch |
|-------------------------------|--------|--------|---------|---------|
| HYUNDAI H-1, 5-dr Van, 08- | 850 mm | 700 mm | 33 1/2" | 27 1/2" |
| HYUNDAI iLoad, 5-dr Van, 08- | 850 mm | 700 mm | 33 1/2" | 27 1/2" |
| HYUNDAI iMax, 5-dr Bus, 08- | 850 mm | 700 mm | 33 1/2" | 27 1/2" |
| HYUNDAI Starex, 5-dr Van, 08- | 850 mm | 700 mm | 33 1/2" | 27 1/2" |

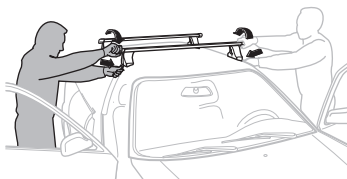
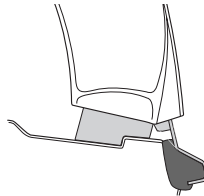
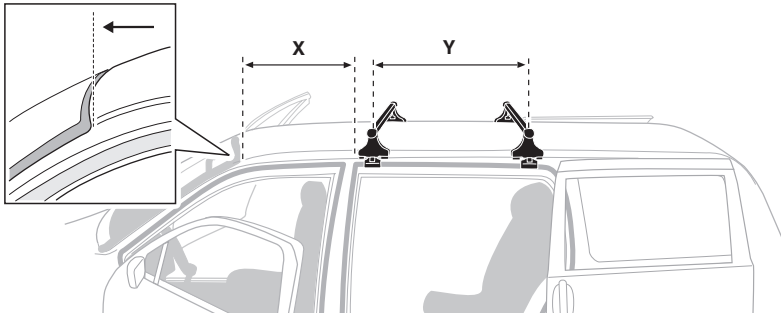

GB/US Tighten alternately

D Die Schrauben abwechselnd anziehen

F Serrer alternativement chaque côté

NL Afwisselend aan de linker- en de rechterkant aandraaien

I Alternare il serraggio delle viti

E Serrare alternativamente

PT Aperte alternadamente

S Dra åt växelvis

FIN Kierrä vuorotellen

EST Pinguldage vaheldumisi

LAT Pieveļciet pamišus

LIT Užsukinėkite pakaitomis

PL Śruby dokręcaj naprzemiennie

RU Затягивайте попеременно

CZ Pokręťta bagažníka dokręcaj dokręcaj naprzemiennie.

SK Doťahujte striedavo

SLO Privijajte izmenično.

HR Naizmjenično zategnite

HU Egymástól függetlenül szorítandó

GR Σφιγγετε εναλλάξ

TR Dönüşümlü sıkın

中文 交替拧紧

한국어 번갈아 가며 조이십시오.

日本語 交互に締め付けてください。

ไทย ชันโนแบบสลับ

6

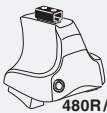

480R/754



480

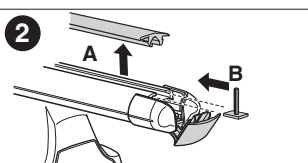
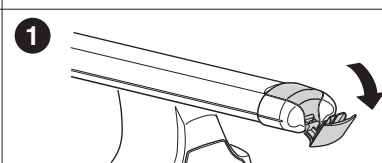
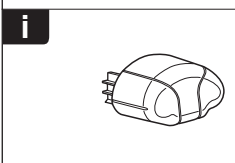
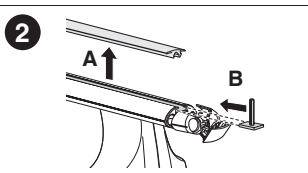
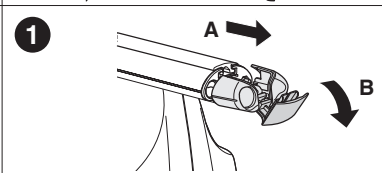
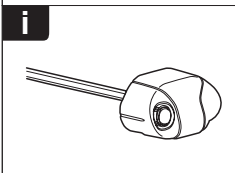
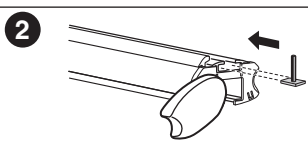
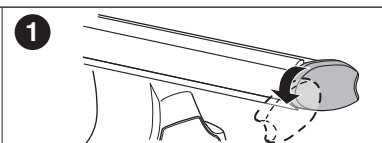
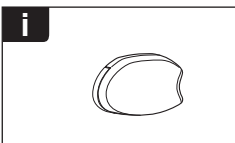
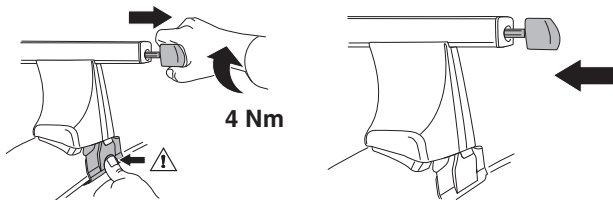
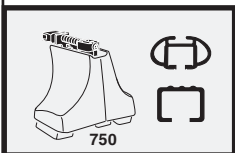
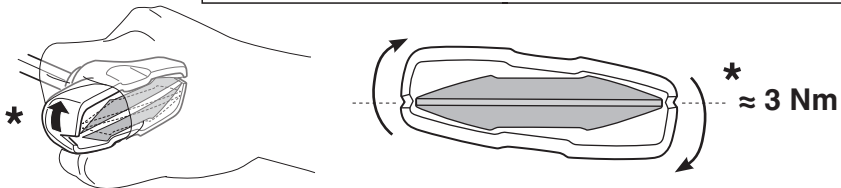
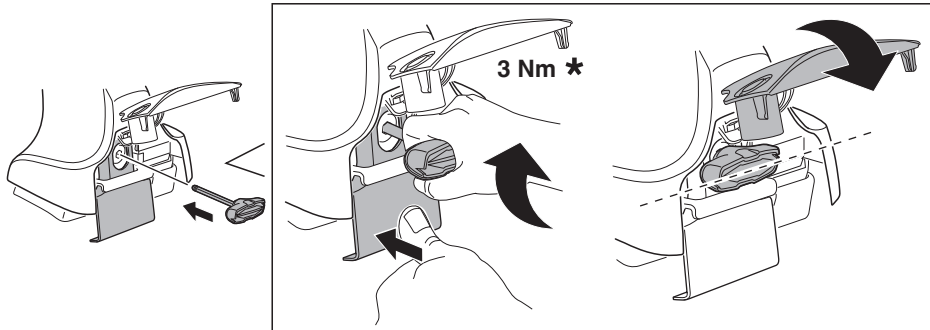

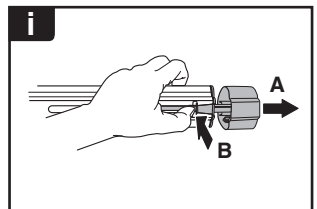
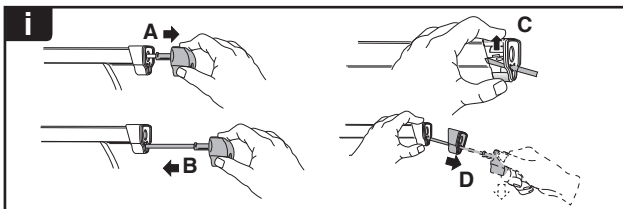
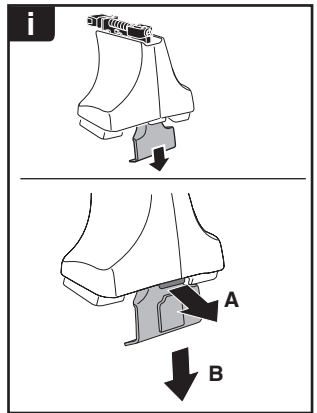
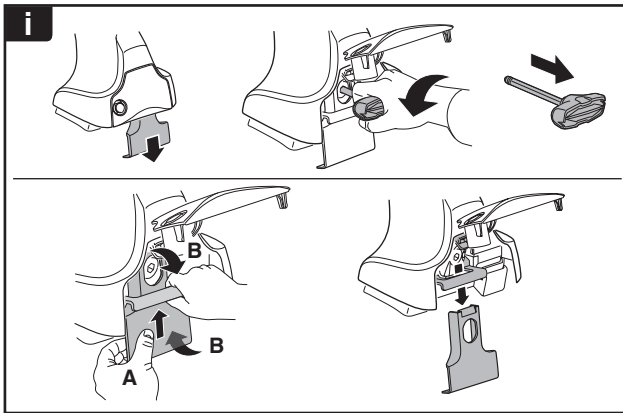
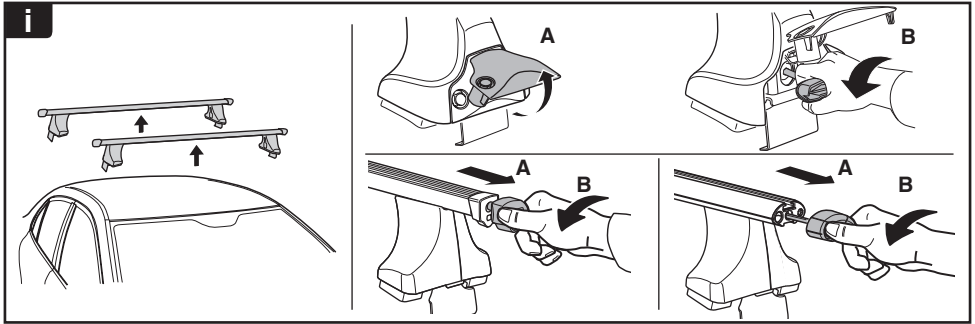

THULE
SWEDEN
**ONE
KEY
SYSTEM**

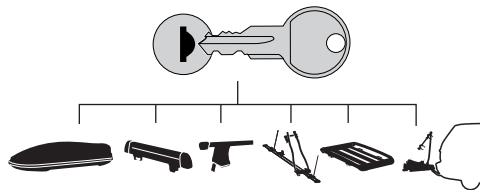

- 544 (x4)
- 596 (x6)
- 588 (x8)
- NA 510 (x10)
- EUR 452 (x12)
- ASIA

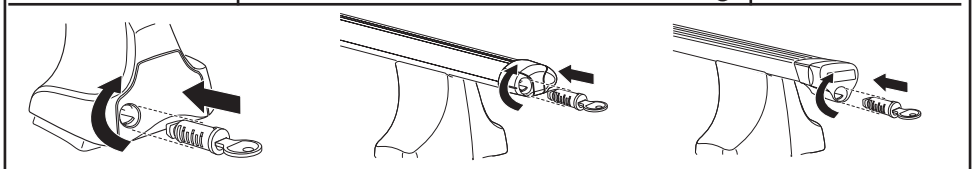



WW ▶ Thule Sweden AB, Box 69, 330 33 Hillerstorp, SWEDEN
 NA ▶ Thule Inc., 42 Silvermine Road, Seymour, Connecticut 06483, USA

info@thule.com
 customer.service@thule.com

www.thule.com

 www.thuleprofessional.com

 info@thule.com
customer.service@thule.com

 Thule Inc., 42 Silvermine Road, Seymour, Connecticut 06483, USA
Thule Sweden AB, Box 69, 330 33 Hillerstorp, SWEDEN

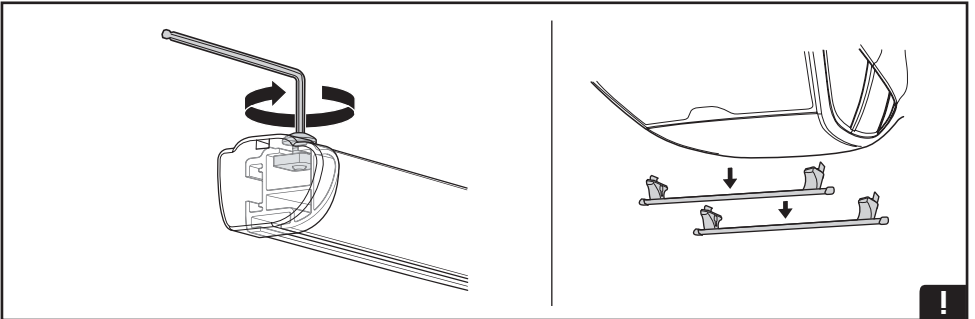
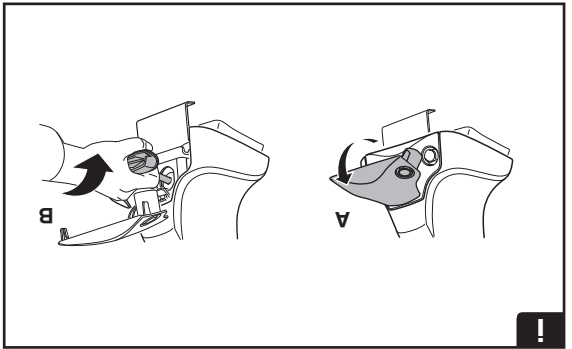
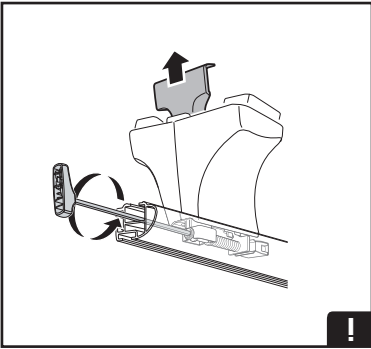
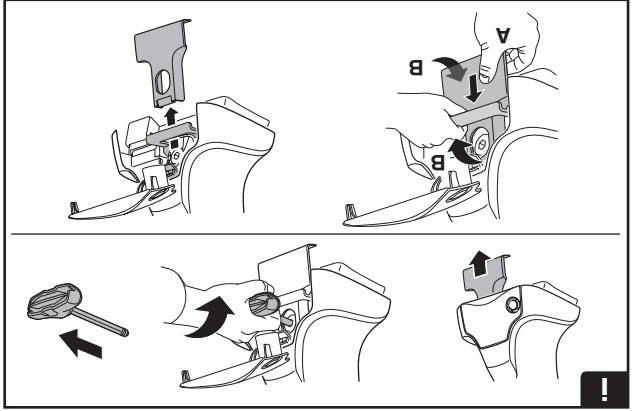
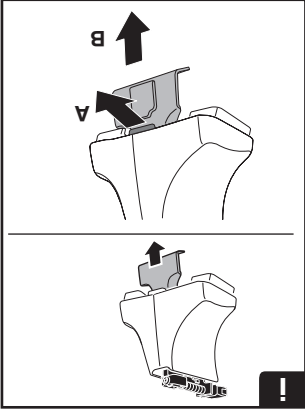

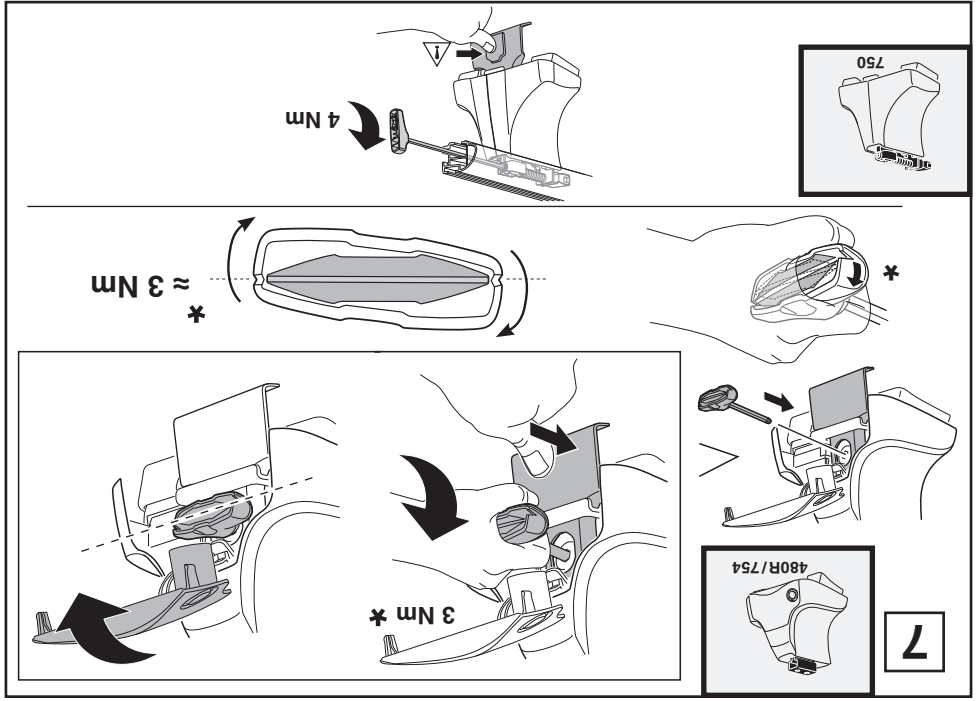
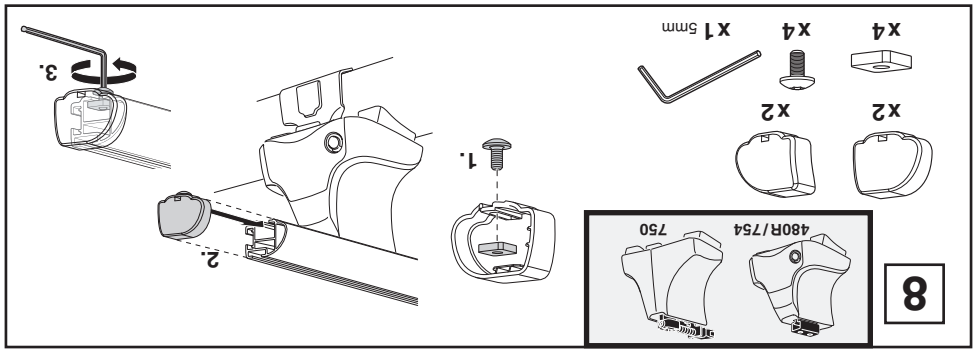
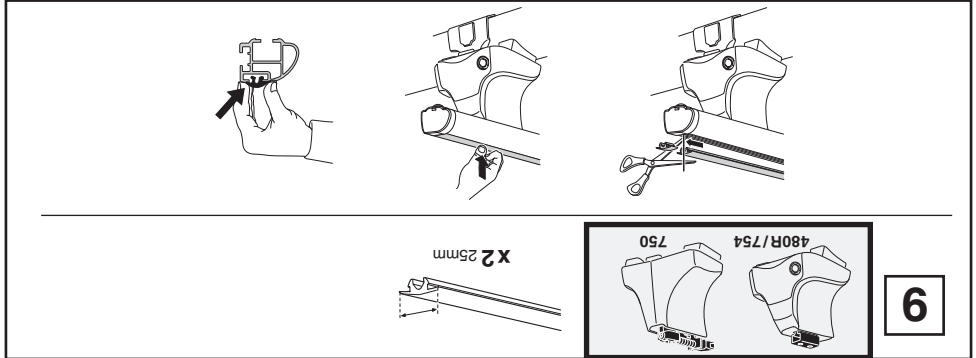

- S Dra åt växelvis
- PT Aperte alternativamente
- E Serrare alternativamente
- I Alternare il serraggio delle viti
- NL de rechterkant aandraken
- F Serrer alternativement chaque côté
- D Die Schrauben abwechselnd
- GB/US Tighen alternatively

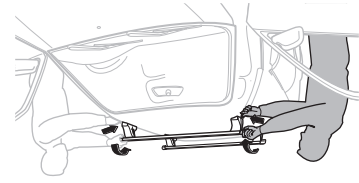

- FIN Kierää vuorotellen
- EST Pinguldage vaheldumisi
- LAT Pīvelciēt pamīšus
- LIT Ūsukinėkite pakaitomis
- PL Śruby dokręcaj naprzemiennie
- RU Затягивайте попеременно
- CZ Pokrétá bagazníka dokręcaj
- SK Dotiahúťe striedavo dokręcaj naprzemiennie
- SLO Privijajte izmenično
- HR Naizmjerno zategnite
- HU Egyrésztől fűggetlenül szorítandó
- GR Αφίπυετε εναλλάξ
- TR Dönüşümüü sikin
- 中文 交替拧紧
- 한국어 번갈아 가며 조이십시오.
- 日本語 交互に締め付けください。
- ไทย หมุนสลับกัน

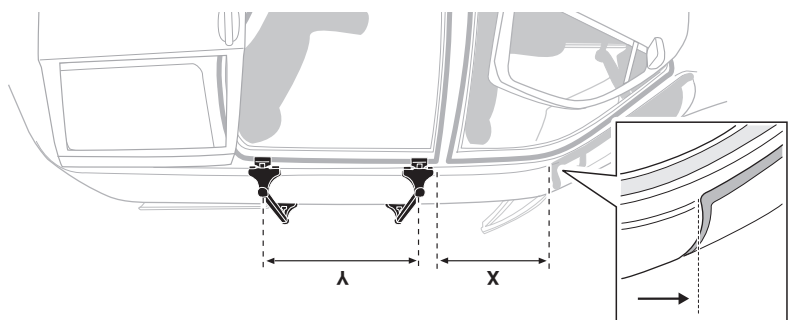
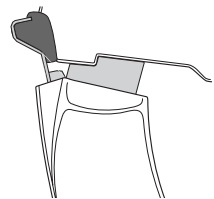

| | | | | |
|-------------------------------|--------|--------|---------|---------|
| HYUNDAI H-1, 5-dr Van, 08- | 850 mm | 700 mm | 33 1/2" | 27 1/2" |
| HYUNDAI Load, 5-dr Van, 08- | 850 mm | 700 mm | 33 1/2" | 27 1/2" |
| HYUNDAI Max, 5-dr Bus, 08- | 850 mm | 700 mm | 33 1/2" | 27 1/2" |
| HYUNDAI Starax, 5-dr Van, 08- | 850 mm | 700 mm | 33 1/2" | 27 1/2" |

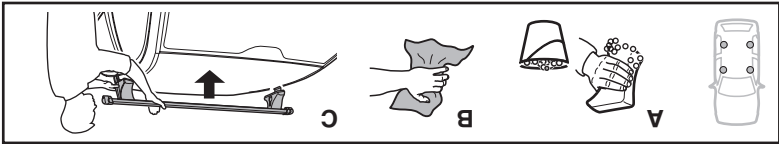

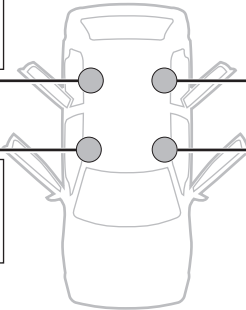
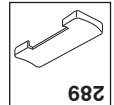
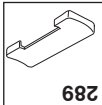
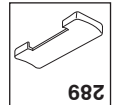
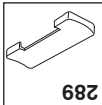
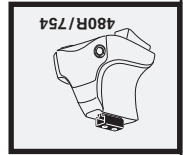
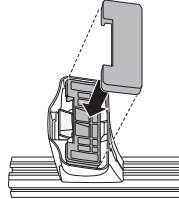
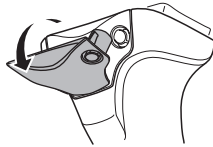
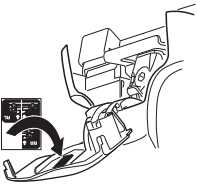
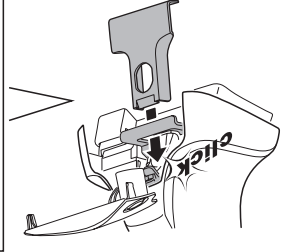
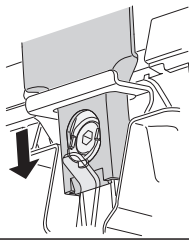
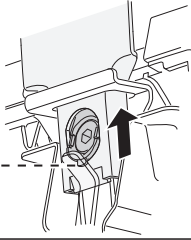
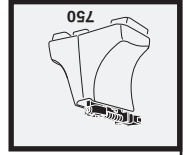
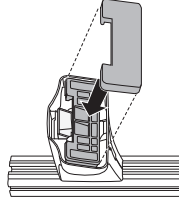
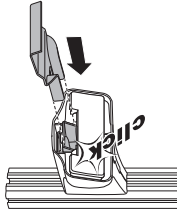
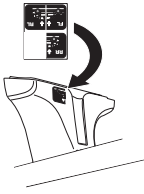

HYUNDAI H-1, 5-dr Van, 08-
HYUNDAI iLoad, 5-dr Van, 08-
HYUNDAI iMax, 5-dr Bus, 08-
HYUNDAI Starex, 5-dr Van, 08-

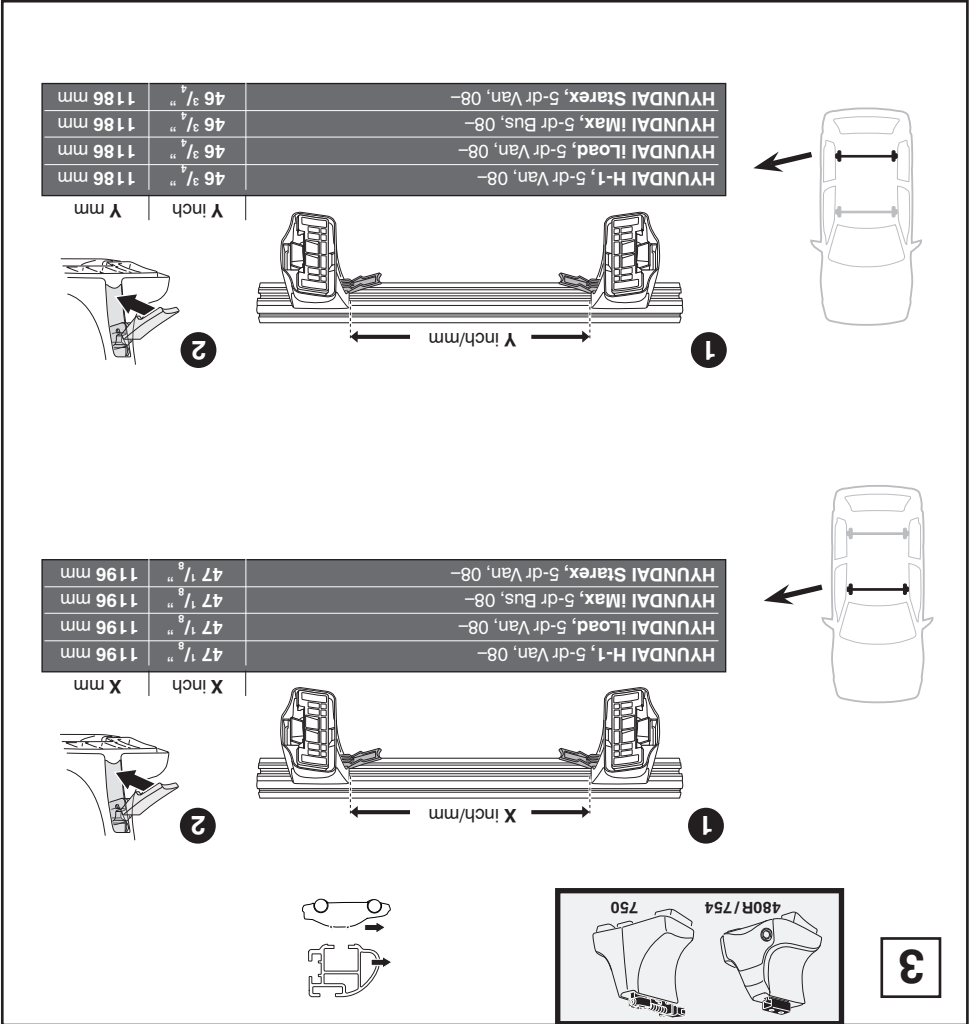
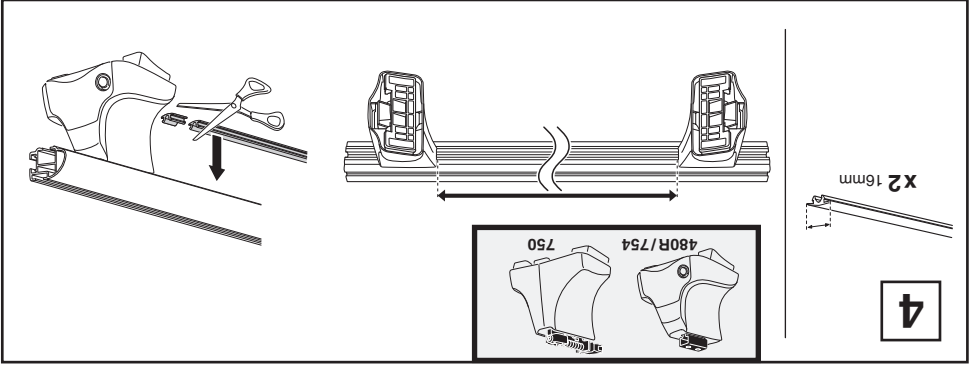

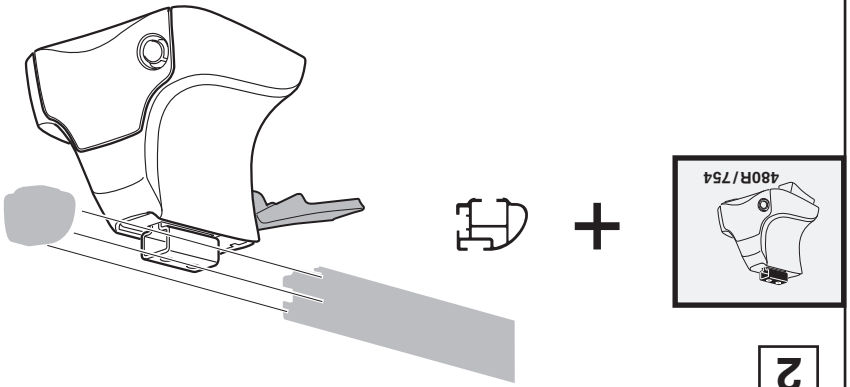
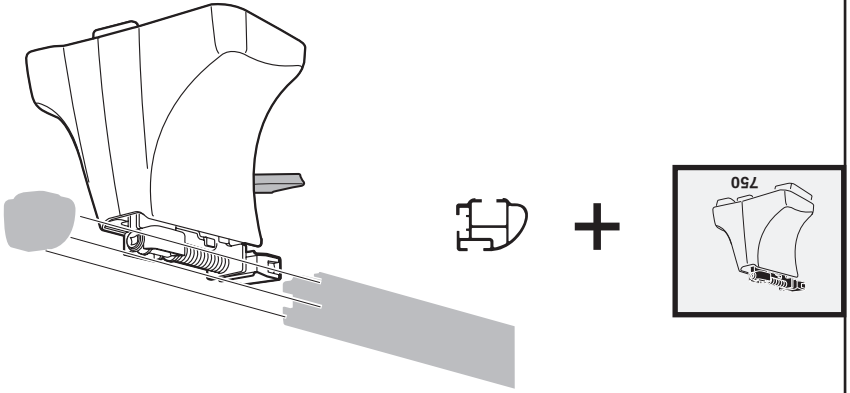

2

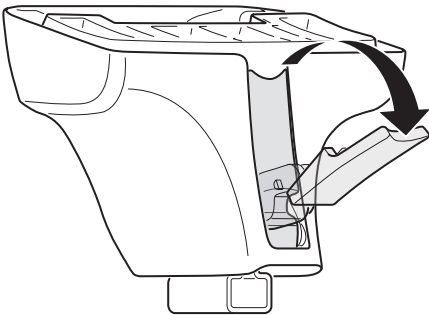

1

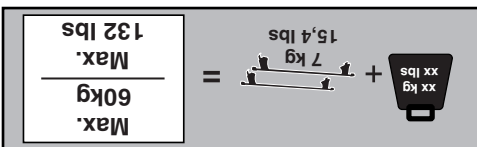
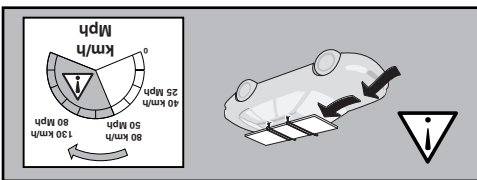
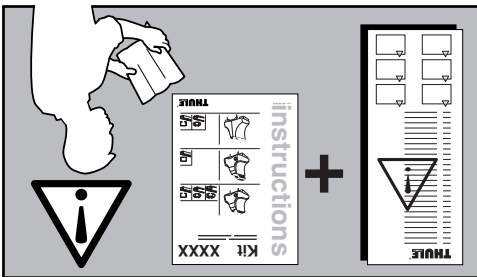
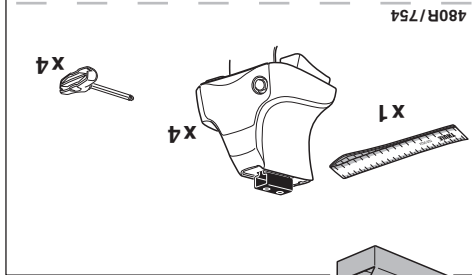
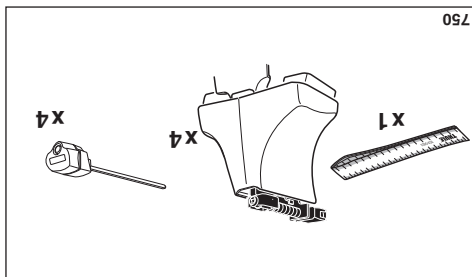
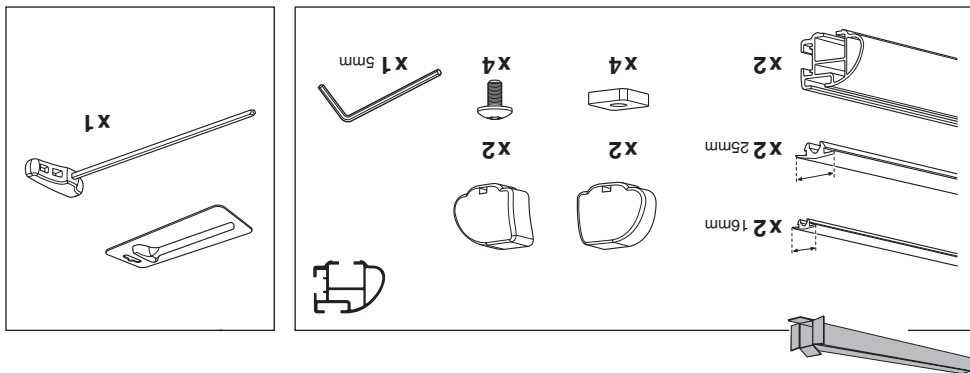
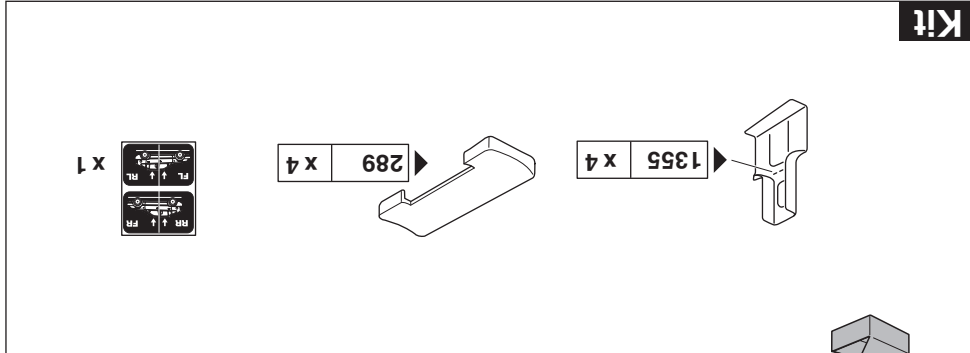

instructions

Kit 1475

HYUNDAI H-1, 5-dr Van, 08-*

HYUNDAI iLoad, 5-dr Van, 08-**

HYUNDAI iMax, 5-dr Bus, 08-**

HYUNDAI Starex, 5-dr Van, 08-*

* with dual sliding doors

** with dual sliding doors (Asia)

480R
754

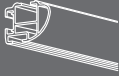
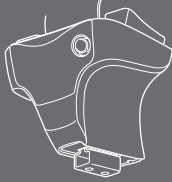

750

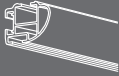
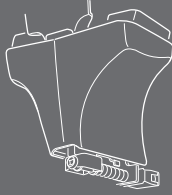

PROFESSIONAL

ISO 11154-E

THULE
SWEDEN