

1

Kit 5063

FORD Ranger, 4-dr Double Cab, 11-
 FORD Ranger, 4-dr Super Cab, 11-



ISO 11154-E

1 KIT

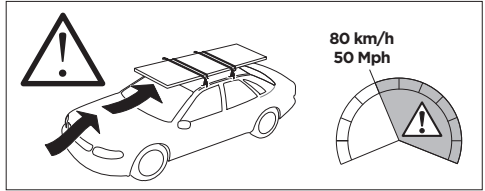
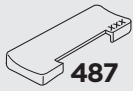
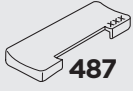
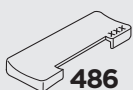
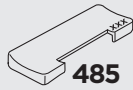
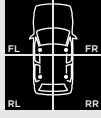

2 FOOT PACK

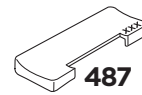
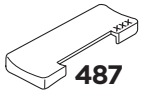
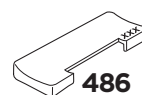
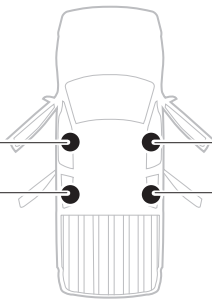
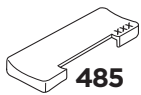
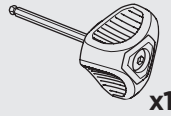
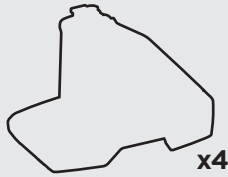

1



2

x4

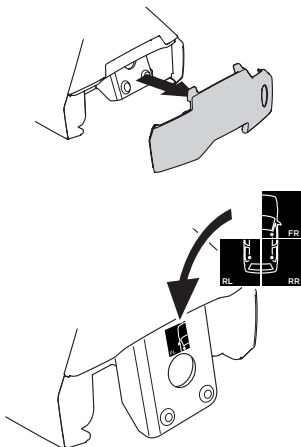

3

x4

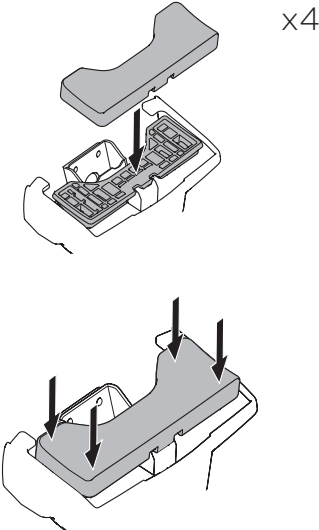
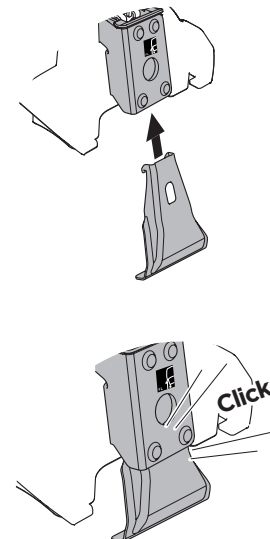

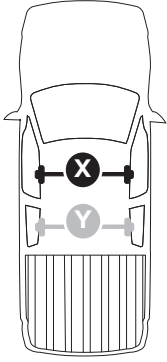

THULE WingBar Evo	THULE WingBar Edge	THULE WingBar	THULE SquareBar	Evo X (scale)	Edge X (scale)
FORD Ranger, 4-dr Double Cab, 11-				47	C
FORD Ranger, 4-dr Super Cab, 11-				47	C

THULE ProBar	THULE SlideBar			X (mm/inch)	
FORD Ranger, 4-dr Double Cab, 11-				1121 mm / 44 1/8"	
FORD Ranger, 4-dr Super Cab, 11-				1121 mm / 44 1/8"	

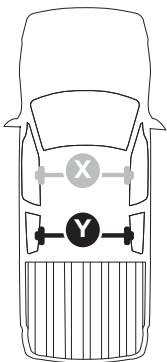

THULE WingBar Evo	THULE WingBar Edge	THULE WingBar	THULE SquareBar	Evo Y (scale)	Edge Y (scale)
FORD Ranger, 4-dr Double Cab, 11-				44,5	H
FORD Ranger, 4-dr Super Cab, 11-				44,5	H

THULE ProBar	THULE SlideBar			Y (mm/inch)	
FORD Ranger, 4-dr Double Cab, 11-				1096 mm / 43 1/8"	
FORD Ranger, 4-dr Super Cab, 11-				1096 mm / 43 1/8"	

	W (mm/inch)	Z (mm/inch)
FORD Ranger, 4-dr Double Cab, 11-	600 mm / 23 5/8"	185 mm / 7 1/4"
FORD Ranger, 4-dr Super Cab, 11-	600 mm / 23 5/8"	185 mm / 7 1/4"

