

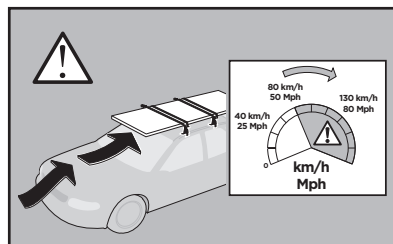

Thule Rapid System Kit 1835

> Instructions

NISSAN Serena, 5-dr MPV, 16-

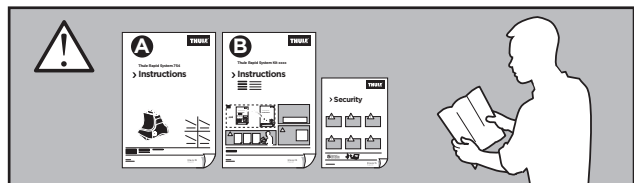
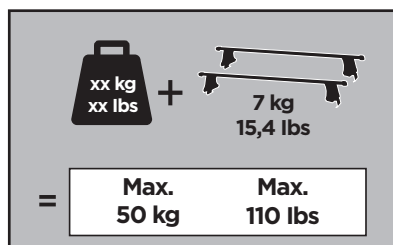
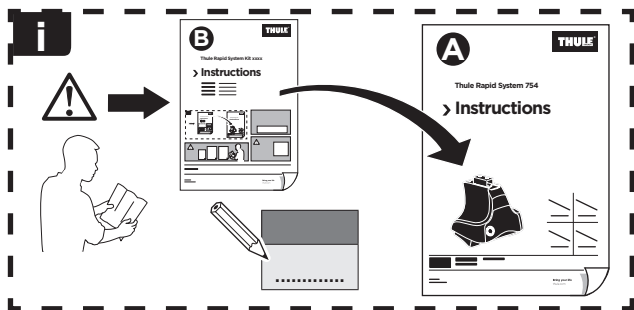

ISO 11154-E

141835

C.20160602
519-1835-01

Bring your life
thule.com



468 x4

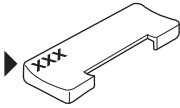

1185 x4



x1



x1

1

	X (scale)	X (mm)	X (inch)
NISSAN Serena, 5-dr MPV, 16-	42,5	1076	42 ³ / ₈

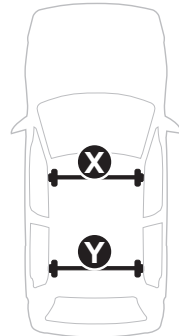
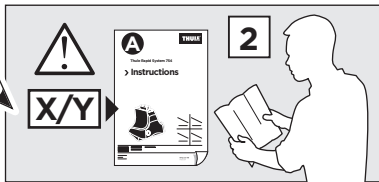
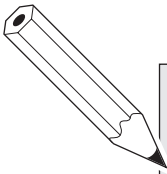

	Y (scale)	Y (mm)	Y (inch)
NISSAN Serena, 5-dr MPV, 16-	43	1081	42 ¹ / ₂

2

NISSAN Serena, 5-dr MPV, 16-

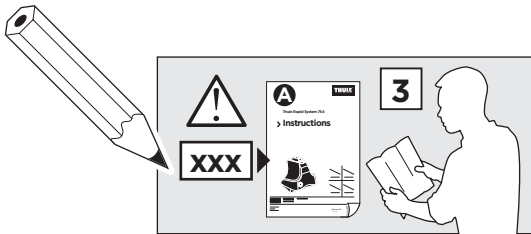
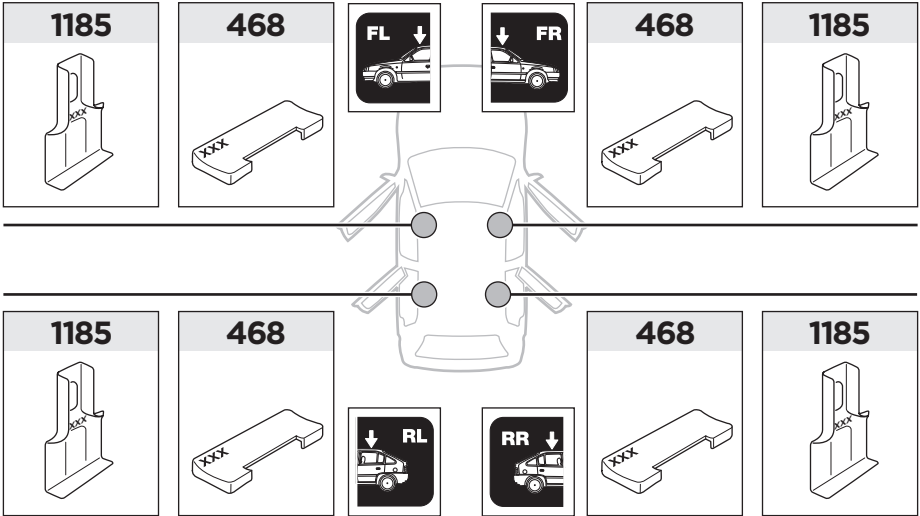

3

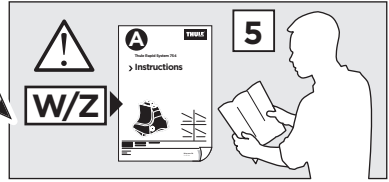

	W (mm)	Z (mm)	W (inch)	Z (inch)
NISSAN Serena, 5-dr MPV, 16-	765	720	30 1/8	28 3/8

