

# 1

## Kit 5179

CHEVROLET Colorado, 4-dr Crew Cab, 15-  
 GMC Canyon, 4-dr Crew Cab, 15-  
 ISUZU D-Max, 4-dr Crew Cab, 12-



ISO 11154-E

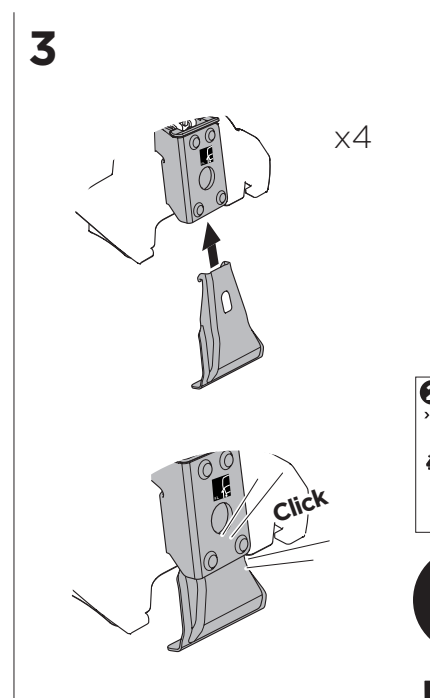
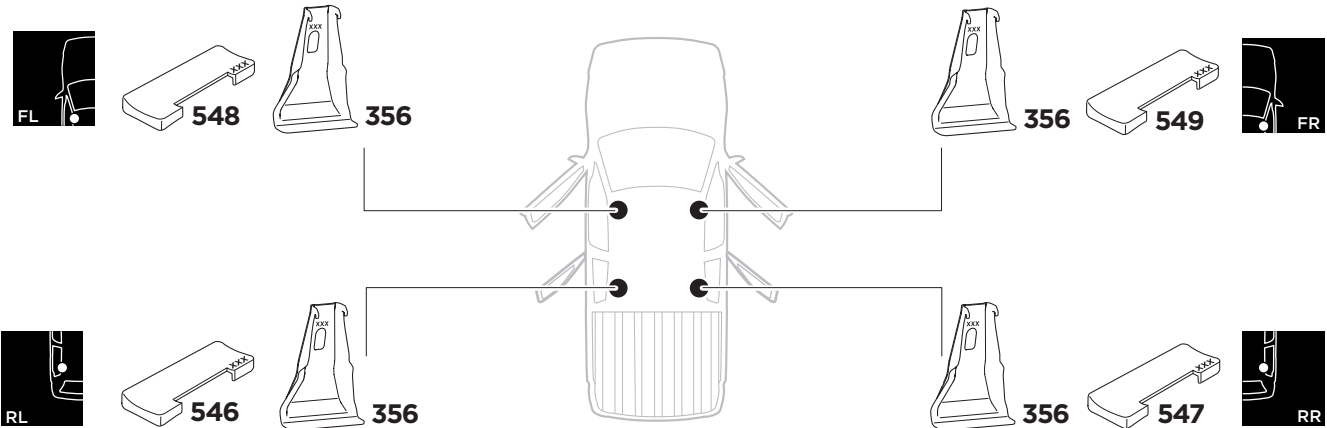
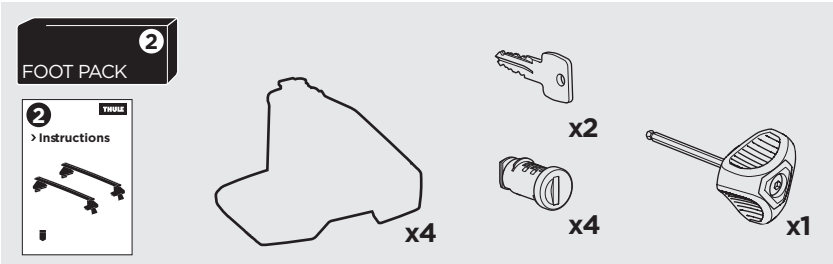
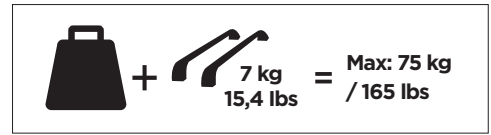
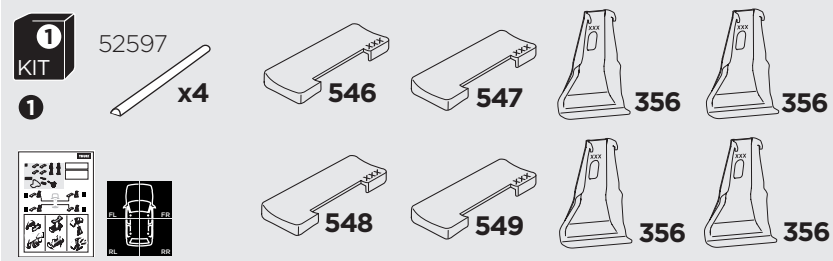

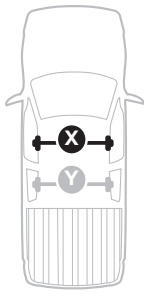

THULE WingBar Evo            THULE WingBar Edge            THULE WingBar            THULE SquareBar	Evo X (scale)	Edge X (scale)
CHEVROLET Colorado, 4-dr Crew Cab, 15-	42	M
GMC Canyon, 4-dr Crew Cab, 15-	42	M
ISUZU D-Max, 4-dr Crew Cab, 12-	42	M

THULE ProBar            THULE SlideBar	X (mm/inch)
CHEVROLET Colorado, 4-dr Crew Cab, 15-	1071 mm / 42 1/8"
GMC Canyon, 4-dr Crew Cab, 15-	1071 mm / 42 1/8"
ISUZU D-Max, 4-dr Crew Cab, 12-	1071 mm / 42 1/8"

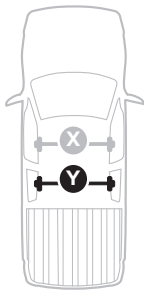

THULE WingBar Evo            THULE WingBar Edge            THULE WingBar            THULE SquareBar	Evo Y (scale)	Edge Y (scale)
CHEVROLET Colorado, 4-dr Crew Cab, 15-	41,5	N
GMC Canyon, 4-dr Crew Cab, 15-	41,5	N
ISUZU D-Max, 4-dr Crew Cab, 12-	41,5	N

THULE ProBar            THULE SlideBar	Y (mm/inch)
CHEVROLET Colorado, 4-dr Crew Cab, 15-	1066 mm / 42"
GMC Canyon, 4-dr Crew Cab, 15-	1066 mm / 42"
ISUZU D-Max, 4-dr Crew Cab, 12-	1066 mm / 42"

	W (mm/inch)	Z (mm/inch)
CHEVROLET Colorado, 4-dr Crew Cab, 15-	700 mm / 27 1/2"	300 mm / 11 3/4"
GMC Canyon, 4-dr Crew Cab, 15-	700 mm / 27 1/2"	300 mm / 11 3/4"
ISUZU D-Max, 4-dr Crew Cab, 12-	700 mm / 27 1/2"	300 mm / 11 3/4"

